

Oblique Towel Ring and Double Robe Hook

Fitting instructions

Included in the box:

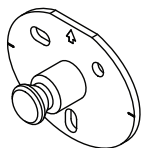

x 1 fixing plates



x 3 screws



x 3 wall plugs



x 1 hex key



x 1 grub screws

You will also need:

Drill with 5mm masonry drill bit
Medium cross head screwdriver
Tape measure
Spirit level
Pencil

Important information, please read carefully before you start:

- If in doubt about any of these instructions, consult a qualified trades person.
- Before starting, ensure that the wall is of a suitable strength and construction and that it is flat and even. You may need help to hold the item during marking and fixing. Ensure you will be able to remove your guide marks from the surface once the product is in position.
- The wall plugs supplied are suitable for solid stone or brick walls. For other wall types (eg plasterboard), use appropriate wall plugs.
- Before drilling, check for hidden pipes or power cables.
- Take care when using power tools, especially near water. The use of a residual current device is recommended. If in doubt refer to drill manufacturer's instructions.
- If drilling glazed tile surfaces, use a tile/ceramic drill bit for this purpose.
- **Handy tip** - using a piece of masking tape on the wall helps prevent the drill from slipping.
- Always wear suitable eye protection when drilling.
- After fixing, check the fitting at regular intervals to ensure that the screws have not become loose.
- Please retain this leaflet for future reference.

Warning:

Please take extra care when fitting that you position the product correctly before attaching it to the wall.

These products should always be fitted strictly in accordance with the fitting instructions. Robert Welch Designs Ltd cannot be held liable for damages if these instructions are not adhered to strictly.

Please contact Robert Welch Designs if you have any queries:

Lower High Street Chipping Campden Gloucestershire GL55 6DY UK.
+ 44 (0) 1386 840522
email: sales@welch.co.uk
www.robertwelch.com

Please read carefully:

1

Unscrew the fixing plate from the product using the hex key.

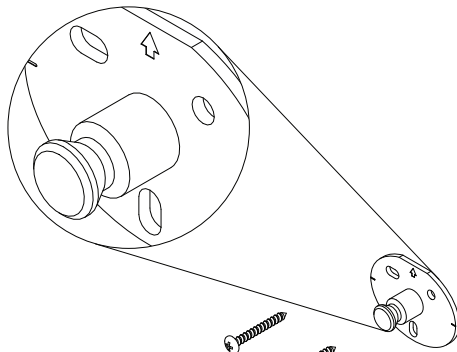

Check with spirit level throughout

2

Establish location using the fixing plate as a template, ensuring that the arrow on the fixing plate is pointing upwards.

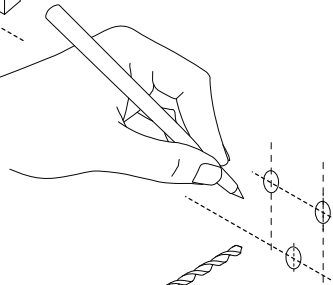

3

Mark hole positions using fixing plate as template.

4

Remove fixing plate and carefully drill holes.

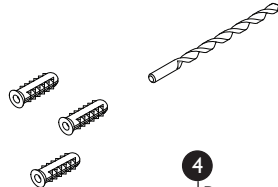

5

Insert wall plugs.

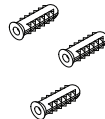

6

Screw fixing plate tightly to surface.

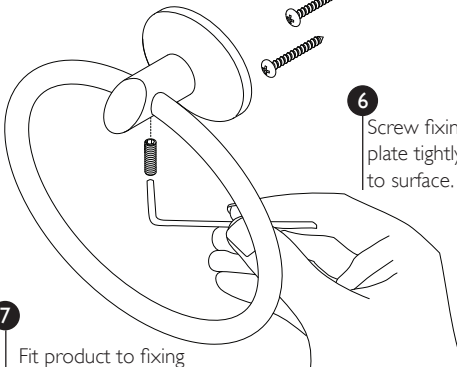

7

Fit product to fixing plate and tighten the grub screw using hex key.

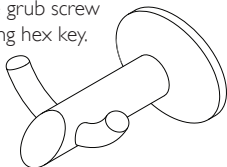

NOTE: Do not drill holes through the fixing plate.